

Klášter Koclířov



Kotelna sestavena z:

- kotle na kusové dřevo: 45 kW
- automatických kotlů: 25 + 25 + 50 kW

Celkový výkon 145 kW

Původní vytápění:

- tepelná čerpadla

Řešení VERNER přineslo:

- stejný komfort
- nižší náklady



Klášter Koclířov

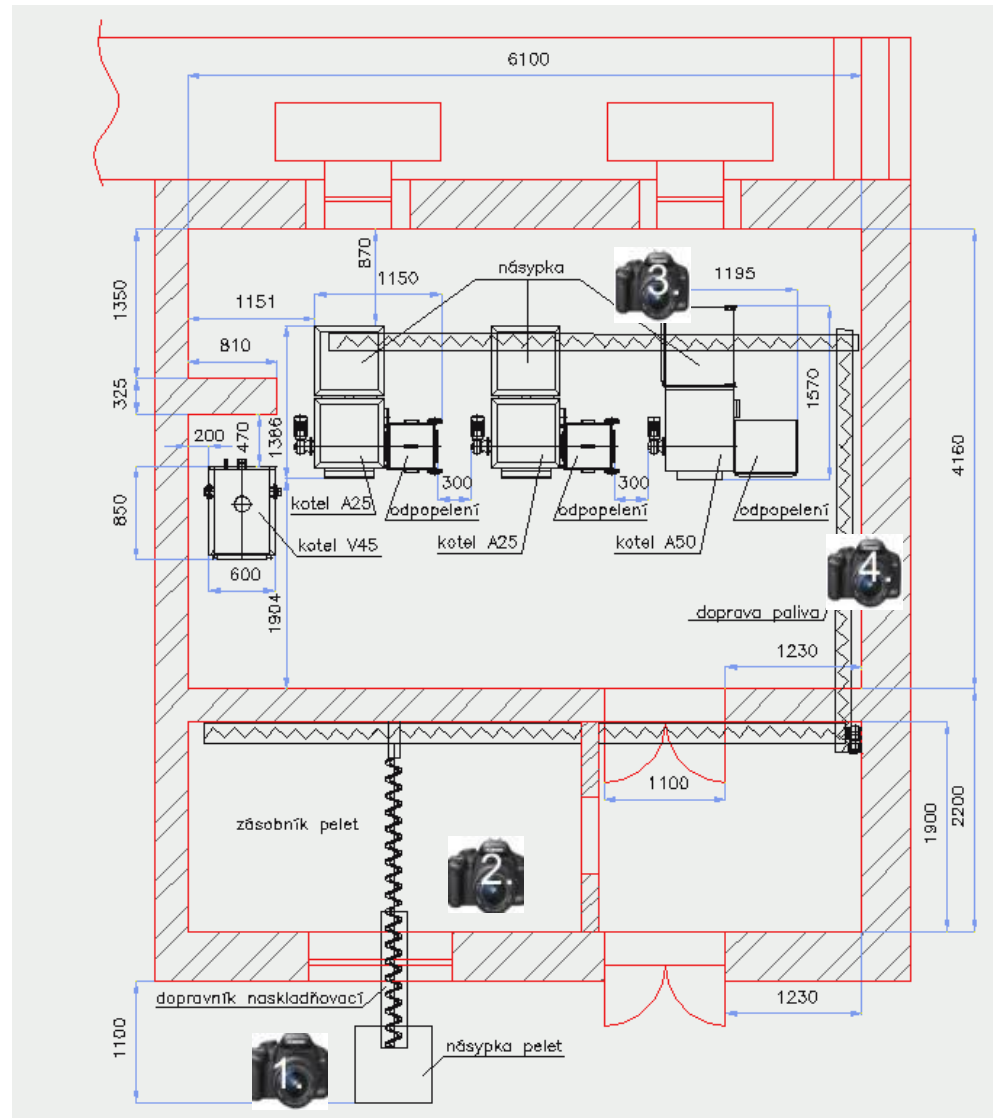

Klášter Koclířov



Kláster Koclířov

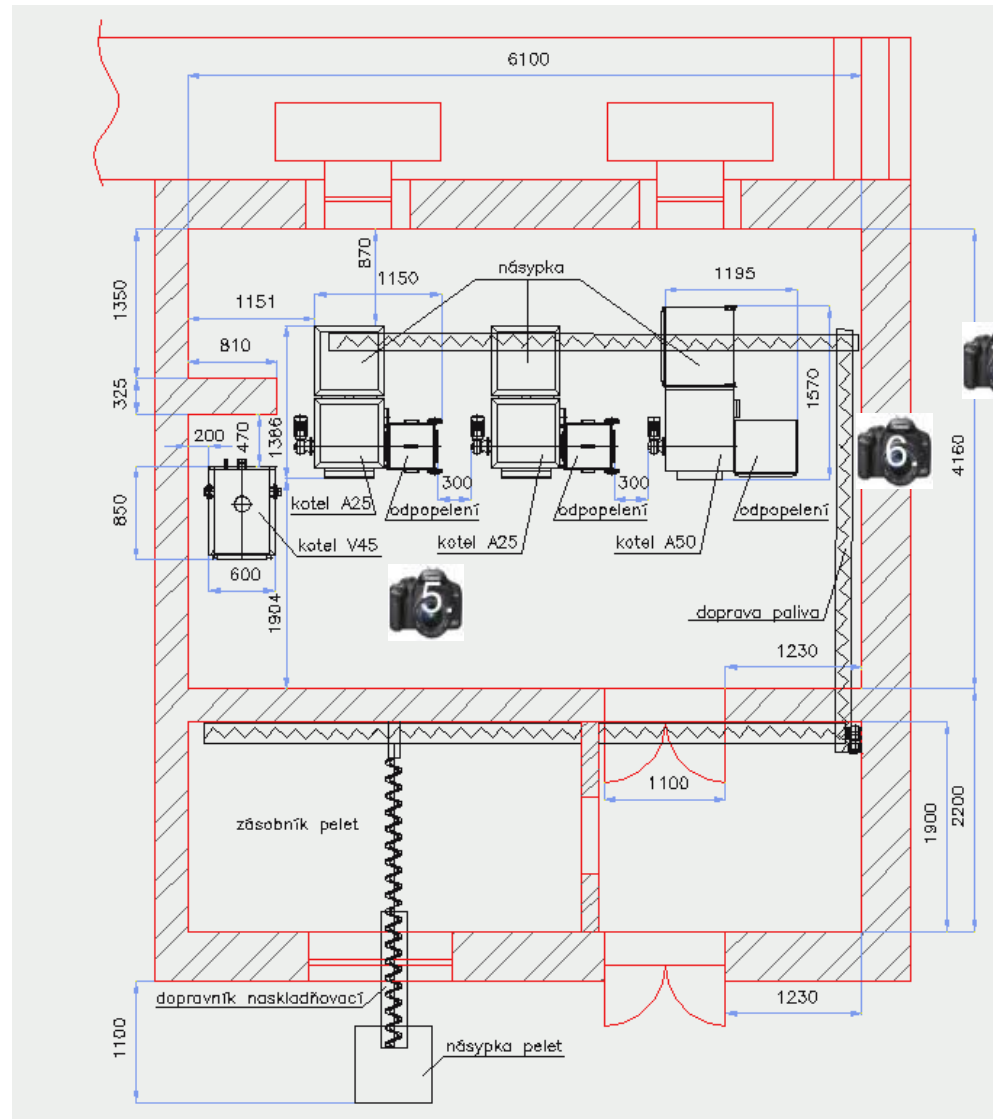

Klášter Koclířov



Poliklinika Broumov

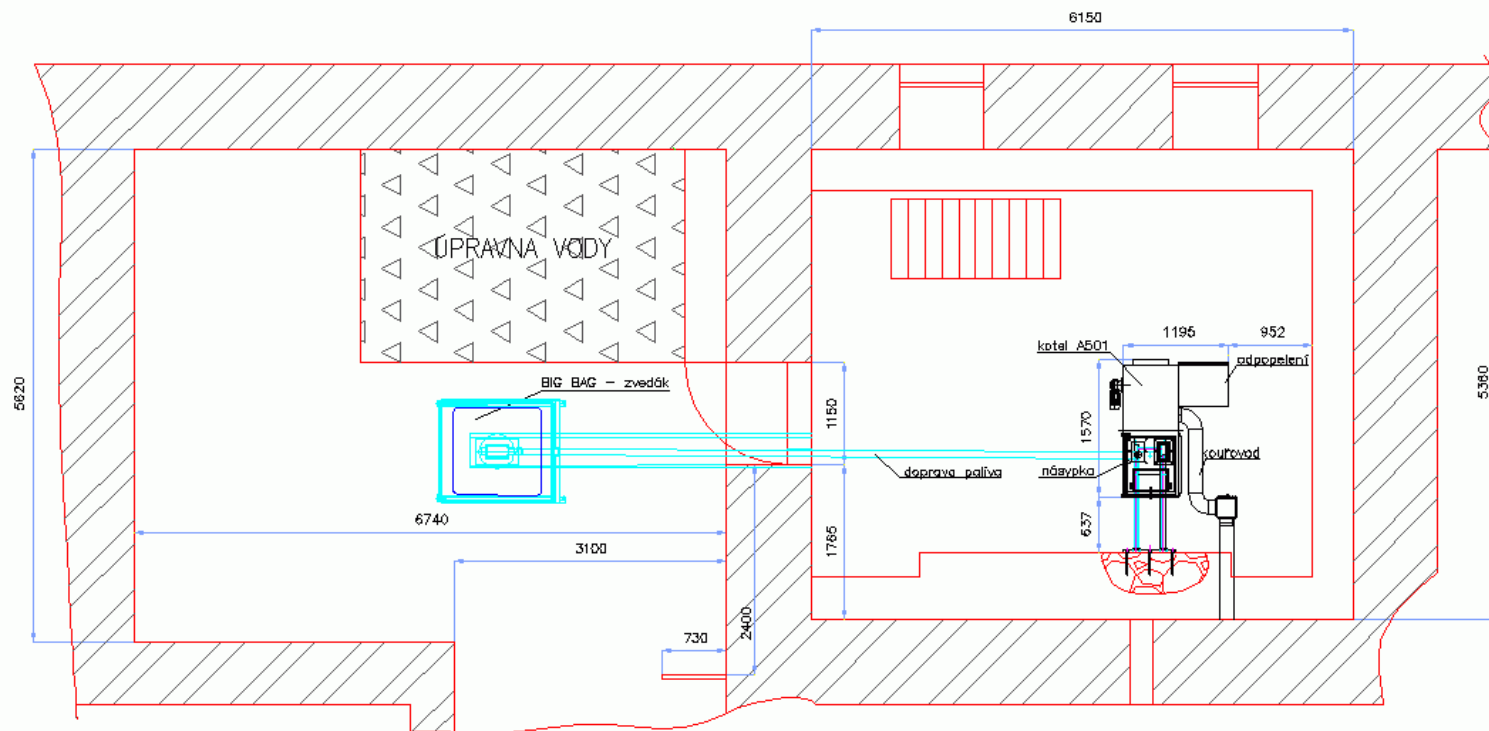

ZŠ Iváň u Brna



ZŠ Iváň u Brna

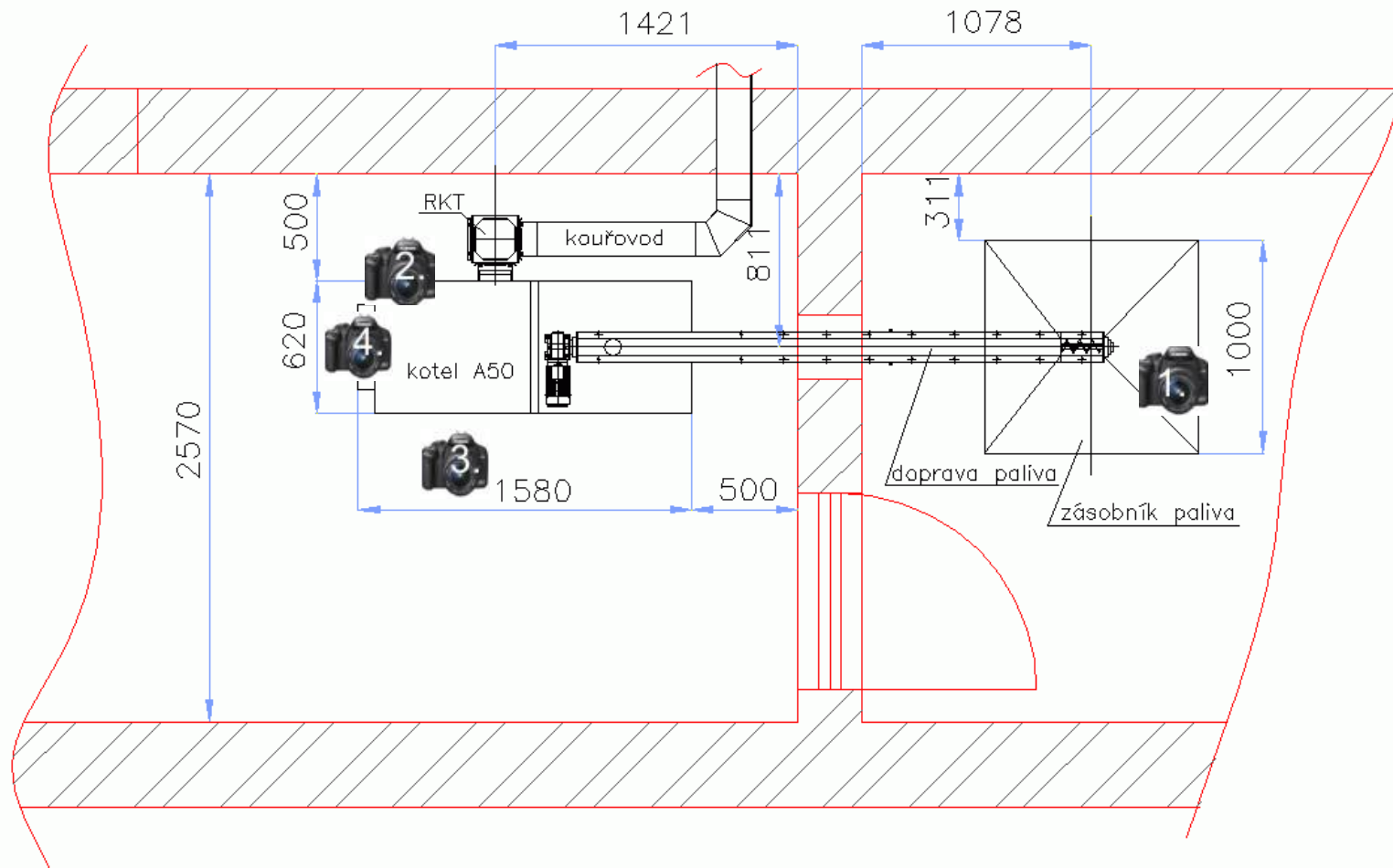

ZŠ Iváň u Brna



Stárkov – základní škola



Stárkov – základní škola

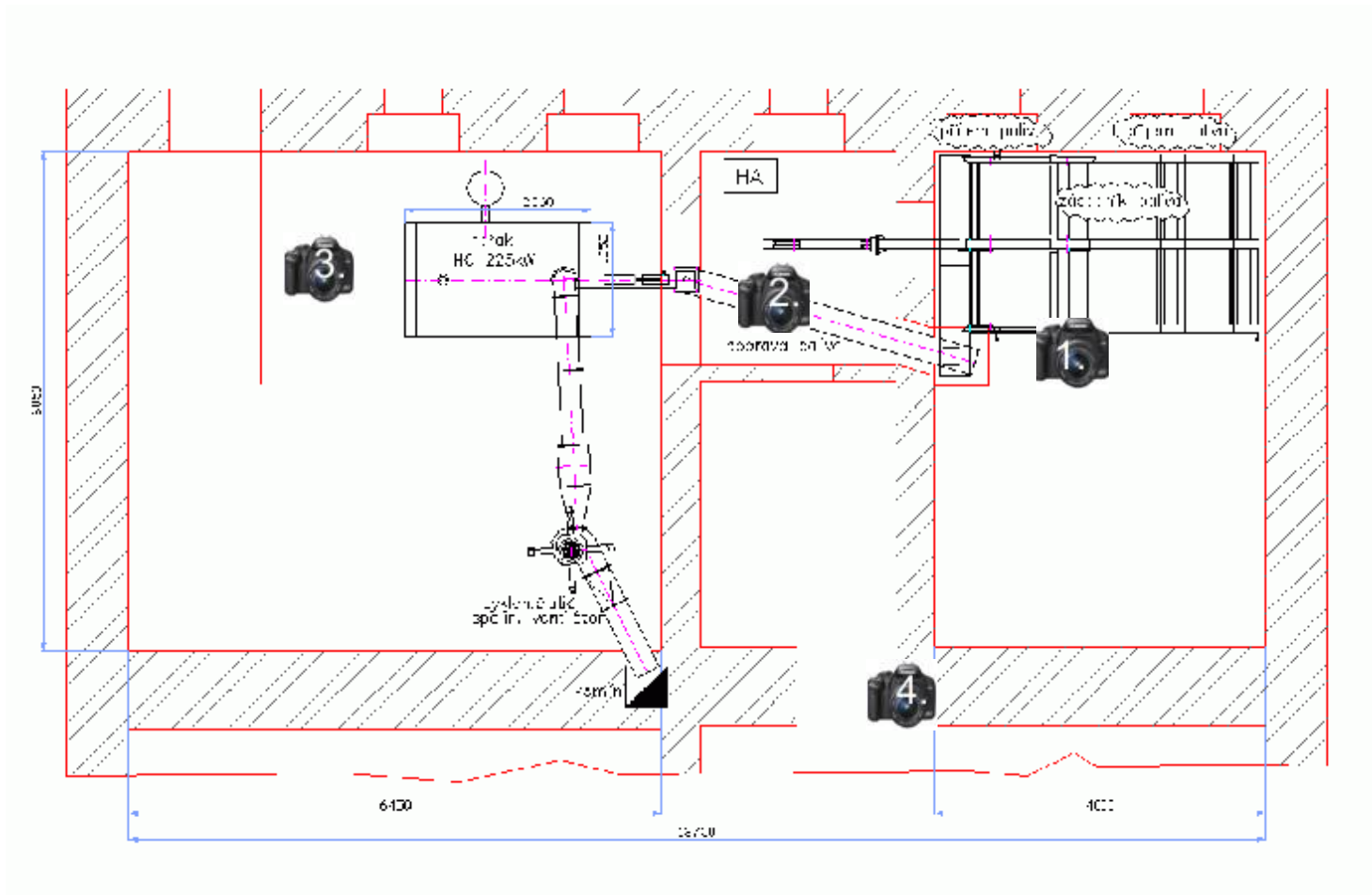

Stárkov – základní škola

1



2



3



4



Stárkov – mateřská škola



Stárkov – mateřská škola

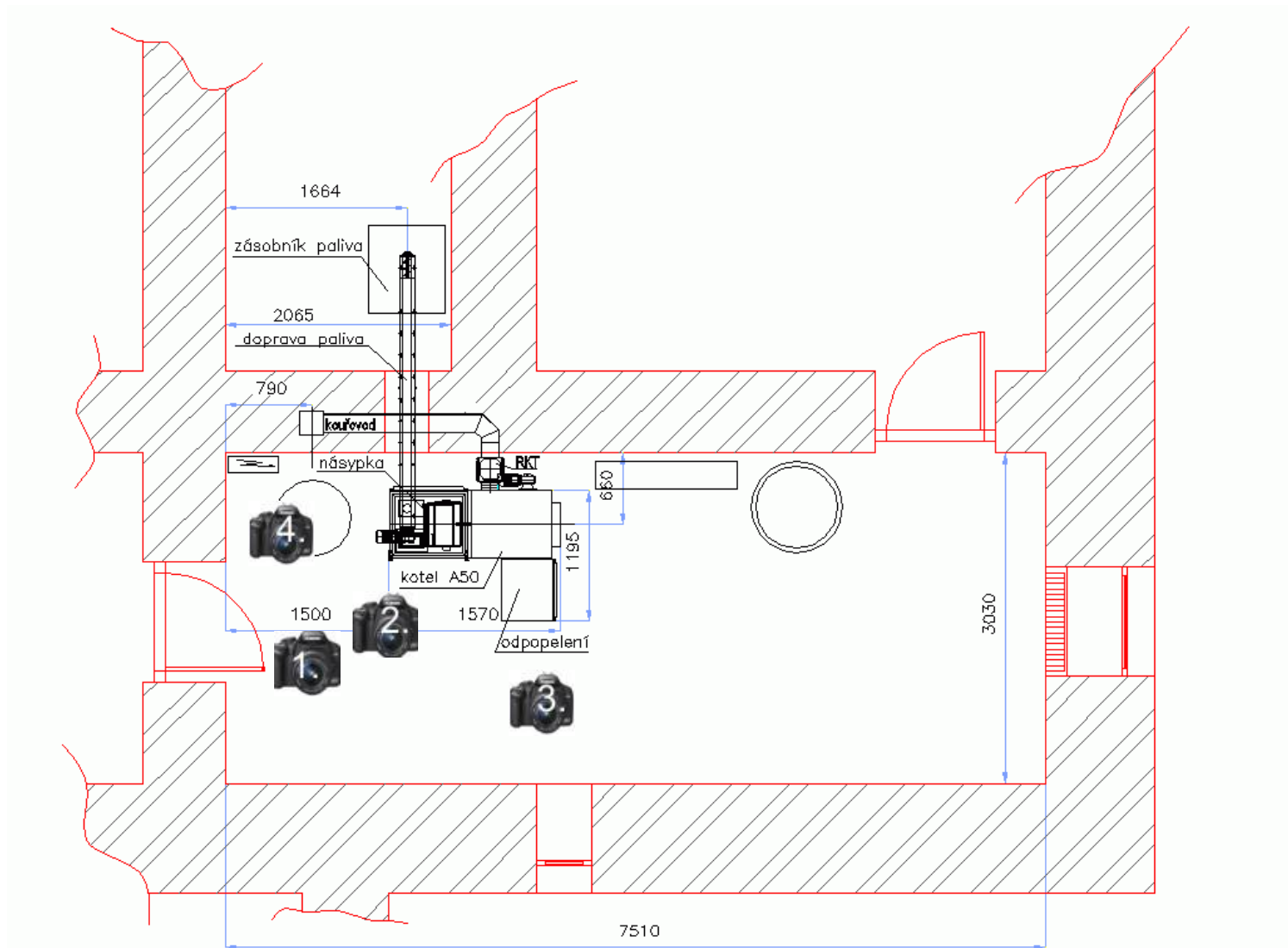

Stárkov – mateřská škola



Králiky – poutní dům



Králiky – poutní dům

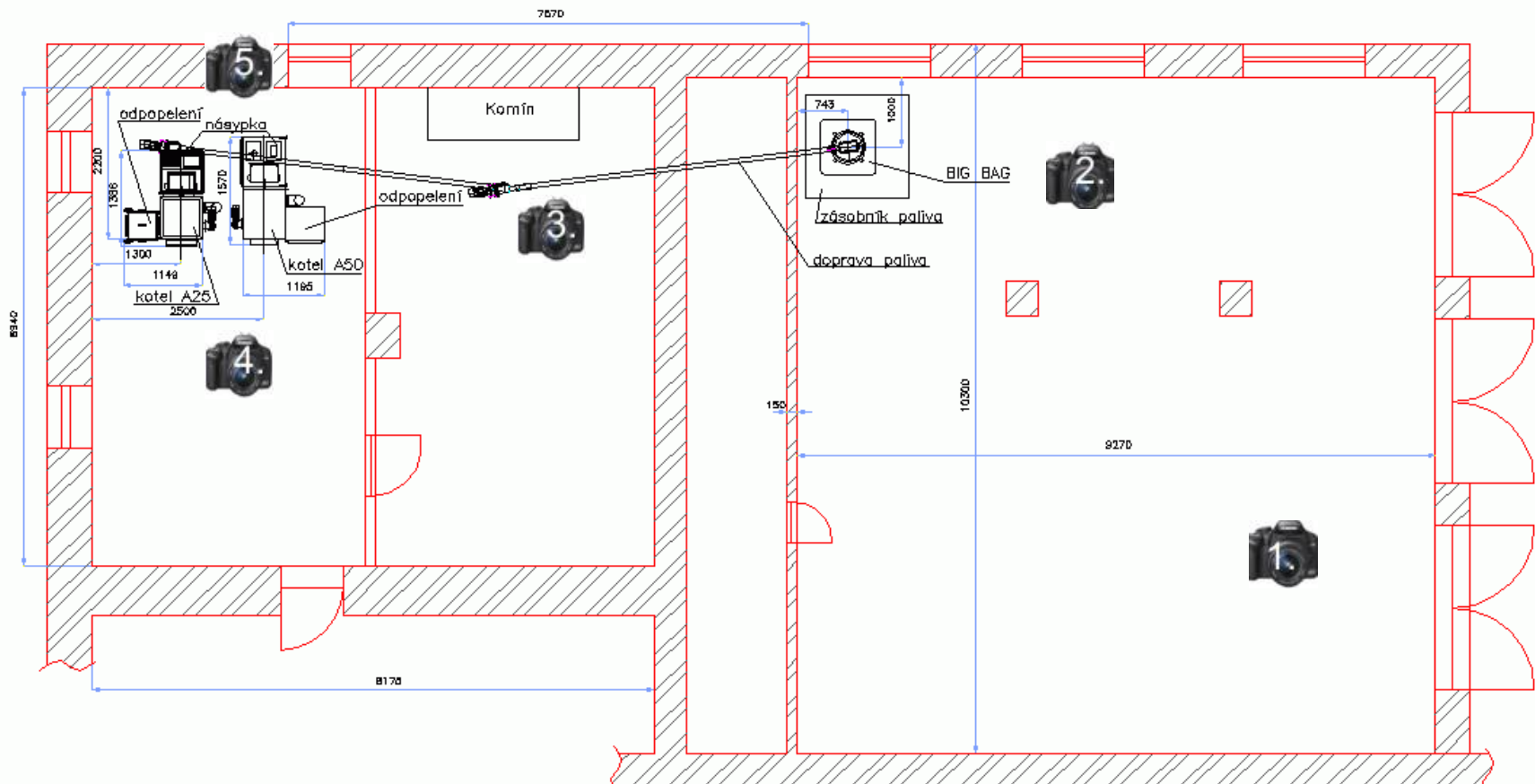

Králiky – poutní dům



Martinkovice – základní škola



Martinkovice – základní škola

Martinkovice
základní škola

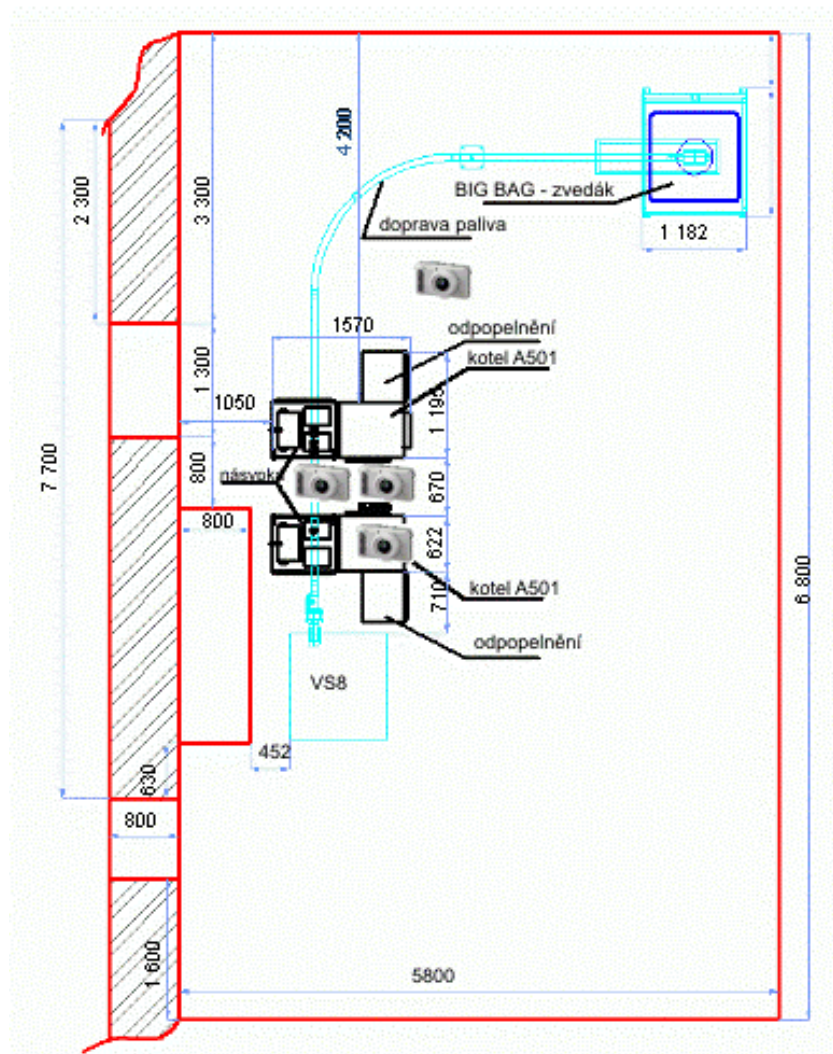

Martínkovice – základní škola



Neratov - obec



Neratov

obecní úřad a pošta



Neratov

hospoda



Neratov

hospoda



Neratov

hospoda – topný sloup



Neratov

chata



Neratov

chata



Neratov

chata u silnice



Neratov

chráněné bydlení



Orlické Záhoří – základní škola



Orlické Záhoří – základní škola

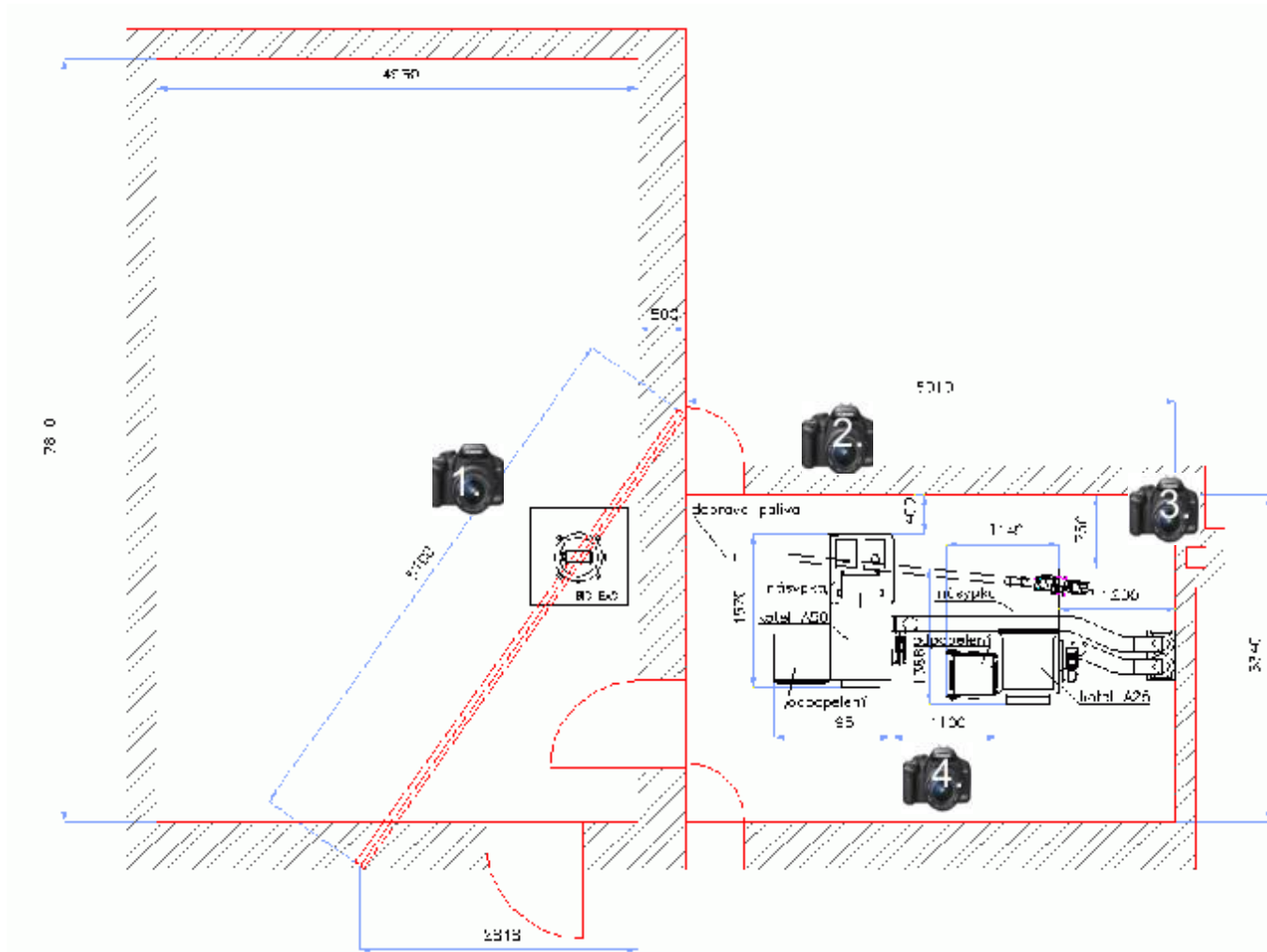

Orlické Záhoří – základní škola



Peletárna Ždírec

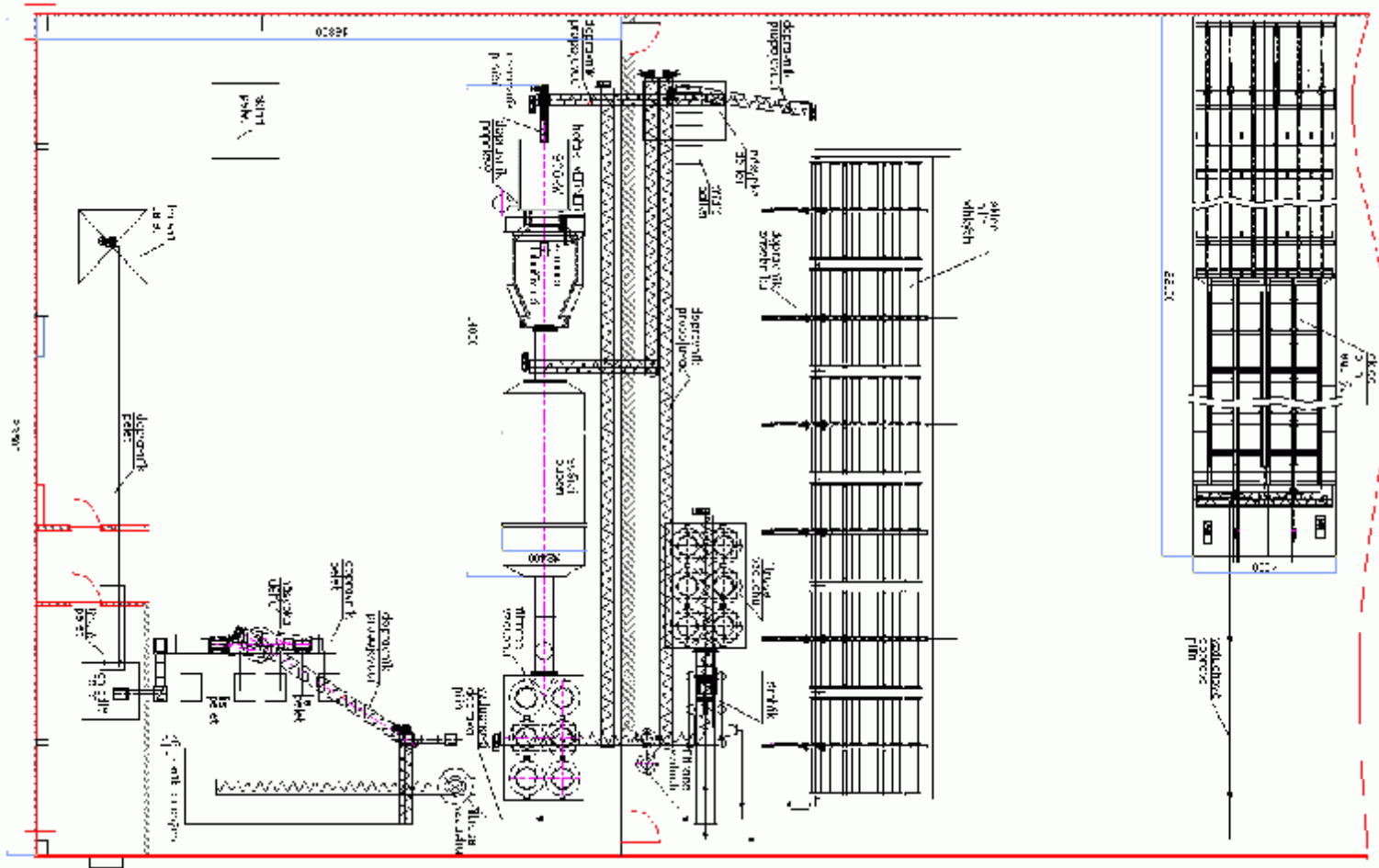

Fara Rychnov



Fara Týniště n. Orlicí



Fara Boušín



Nový Dvůr Klášter Trapistů



Nový Dvůr Klášter Trapistů

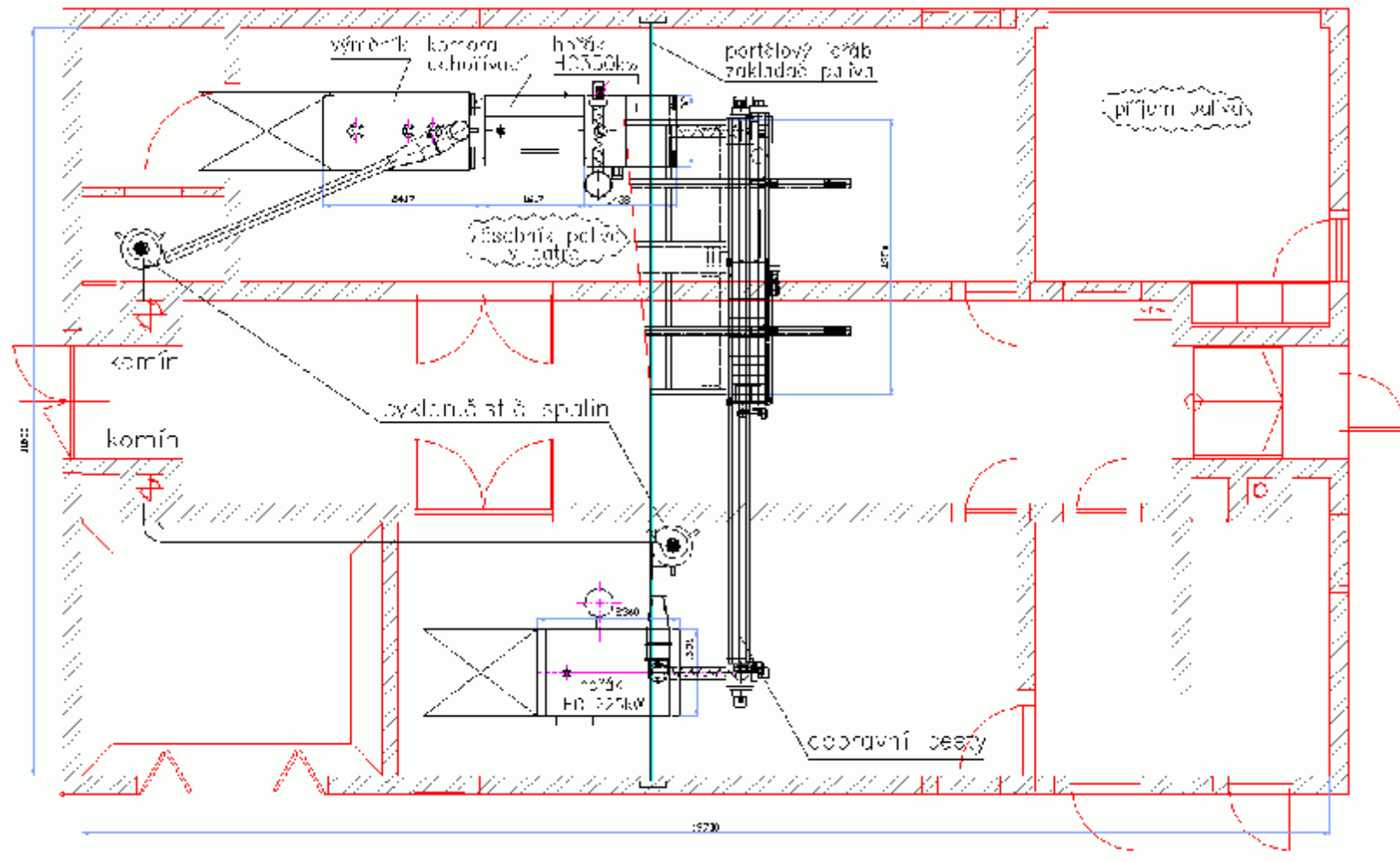

Nový Dvůr Klášter Trapistů

